



Product Summary

$V_{(BR)DSS}$	$R_{DS(on)TYP}$	I_D
30V	22mΩ@10V	16A
	31mΩ@4.5V	
-30V	34mΩ@-10V	-16A
	46mΩ@-4.5V	

Feature

- Trench Technology Power MOSFET
- Low $R_{DS(ON)}$
- Low Gate Charge

Application

- Load Switch
- DC/DC Converter

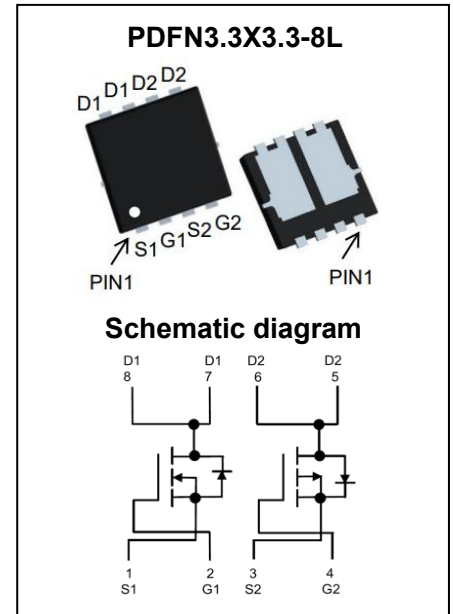

MARKING:



ABSOLUTE MAXIMUM RATINGS ($T_A = 25^\circ\text{C}$ unless otherwise noted)

Parameter	Symbol	Value	Value	Unit	
Drain - Source Voltage	V_{DS}	30	-30	V	
Gate - Source Voltage	V_{GS}	± 20	± 20	V	
Continuous Drain Current ^{1,6}	$T_C = 25^\circ\text{C}$	I_D	16	-16	A
	$T_C = 100^\circ\text{C}$	I_D	10	-10	A
Pulsed Drain Current ²	I_{DM}	64	-64	A	
Single Pulsed Avalanche Current ³	I_{AS}	18	25	A	
Single Pulsed Avalanche Energy ³	E_{AS}	16.2	31.3	mJ	
Power Dissipation ⁵	$T_C = 25^\circ\text{C}$	P_D	17	15	W
Thermal Resistance from Junction to Ambient ⁶	$R_{\theta JA}$	55	50	$^\circ\text{C/W}$	
Thermal Resistance from Junction to Case	$R_{\theta JC}$	7.4	8.3	$^\circ\text{C/W}$	
Junction Temperature	T_J	150	150	$^\circ\text{C}$	
Storage Temperature	T_{STG}	-55~ +150	-55~ +150	$^\circ\text{C}$	

MOSFET ELECTRICAL CHARACTERISTICS ($T_A = 25^\circ\text{C}$ unless otherwise noted)
NMOS:

Parameter	Symbol	Test Condition	Min	Type	Max	Unit
Off Characteristics						
Drain - Source Breakdown Voltage	$V_{(BR)DSS}$	$V_{GS} = 0V, I_D = 250\mu A$	30			V
Zero Gate Voltage Drain Current	I_{DSS}	$V_{DS} = 30V, V_{GS} = 0V$			1	μA
Gate - Body Leakage Current	I_{GSS}	$V_{GS} = \pm 20V, V_{DS} = 0V$			± 100	nA
On Characteristics³						
Gate Threshold Voltage	$V_{GS(th)}$	$V_{DS} = V_{GS}, I_D = 250\mu A$	1	1.7	3	V
Drain-source On-resistance	$R_{DS(on)}$	$V_{GS} = 10V, I_D = 5A$		22	30	m Ω
		$V_{GS} = 4.5V, I_D = 3A$		31	42	
Dynamic Characteristics						
Input Capacitance	C_{iss}	$V_{DS} = 15V, V_{GS} = 0V, f = 1MHz$		512		pF
Output Capacitance	C_{oss}			63		
Reverse Transfer Capacitance	C_{rss}			49		
Gate Resistance	R_g	$V_{DS} = 0V, V_{GS} = 0V, f = 1MHz$		2.4		Ω
Switching Characteristics						
Total Gate Charge	Q_g	$V_{DS} = 15V, V_{GS} = 10V, I_D = 6.9A$		10.7		nC
Gate-source Charge	Q_{gs}			1.7		
Gate-drain Charge	Q_{gd}			2.3		
Turn-on Delay Time	$t_{d(on)}$	$V_{DD} = 15V, V_{GS} = 10V, I_D = 9A,$ $R_G = 3\Omega$		5.7		ns
Turn-on Rise Time	t_r			2.6		
Turn-off Delay Time	$t_{d(off)}$			15.3		
Turn-off Fall Time	t_f			4.1		
Source - Drain Diode Characteristics						
Diode Forward Voltage ⁴	V_{SD}	$V_{GS} = 0V, I_S = 3A$			1.2	V

MOSFET ELECTRICAL CHARACTERISTICS ($T_A = 25^\circ\text{C}$ unless otherwise noted)

PMOS:

Parameter	Symbol	Test Condition	Min	Type	Max	Unit
Off Characteristics						
Drain - Source Breakdown Voltage	$V_{(BR)DSS}$	$V_{GS} = 0V, I_D = -250\mu A$	-30			V
Zero Gate Voltage Drain Current	I_{DSS}	$V_{DS} = -30V, V_{GS} = 0V$			-1	μA
Gate - Body Leakage Current	I_{GSS}	$V_{GS} = \pm 20V, V_{DS} = 0V$			± 100	nA
On Characteristics³						
Gate Threshold Voltage	$V_{GS(th)}$	$V_{DS} = V_{GS}, I_D = -250\mu A$	-1	-1.5	-3	V
Drain-source On-resistance	$R_{DS(on)}$	$V_{GS} = -10V, I_D = -5A$		34	44	m Ω
		$V_{GS} = -4.5V, I_D = -3A$		46	65	
Dynamic Characteristics						
Input Capacitance	C_{iss}	$V_{DS} = -15V, V_{GS} = 0V, f = 1MHz$		978		pF
Output Capacitance	C_{oss}			102		
Reverse Transfer Capacitance	C_{rss}			90		
Gate Resistance	R_g	$V_{DS} = 0V, V_{GS} = 0V, f = 1MHz$		17		Ω
Switching Characteristics						
Total Gate Charge	Q_g	$V_{DS} = -15V, V_{GS} = -10V, I_D = -6.0A$		20.8		nC
Gate-source Charge	Q_{gs}			2.8		
Gate-drain Charge	Q_{gd}			4.2		
Turn-on Delay Time	$t_{d(on)}$	$V_{DD} = -15V, V_{GS} = -10V, I_D = -9A,$ $R_G = 3\Omega$		4.6		ns
Turn-on Rise Time	t_r			2.9		
Turn-off Delay Time	$t_{d(off)}$			15.1		
Turn-off Fall Time	t_f			3.6		
Source - Drain Diode Characteristics						
Diode Forward Voltage ⁴	V_{SD}	$V_{GS} = 0V, I_S = -10A$			1.2	V

Notes :

- 1.The maximum current rating is limited by package.
- 2.Pulse Test : Pulse Width $\leq 10\mu s$, duty cycle $\leq 1\%$.
- 3.EAS condition: $V_{DD} = \pm 15V, V_{GS} = \pm 10V, L = 0.1mH, R_G = 25\Omega$ Starting $T_J = 25^\circ\text{C}$.
- 4.Pulse Test : Pulse Width $\leq 300\mu s$, duty cycle $\leq 2\%$.
- 5.The power dissipation P_D is limited by $T_{J(MAX)} = 150^\circ\text{C}$.
- 6.Device mounted on $1in^2$ FR-4 board with 2oz. Copper, in a still air environment with $T_A = 25^\circ\text{C}$.

Typical Characteristics

NMOS:

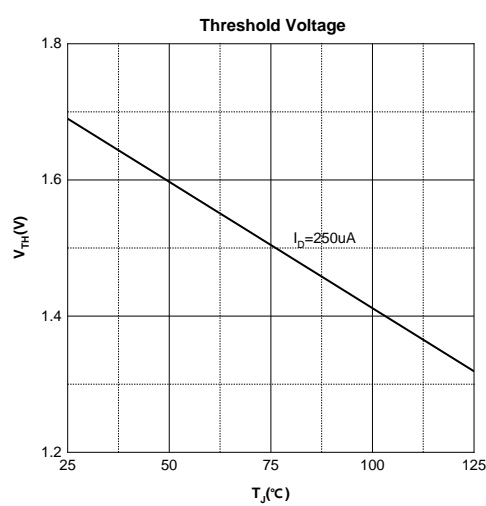
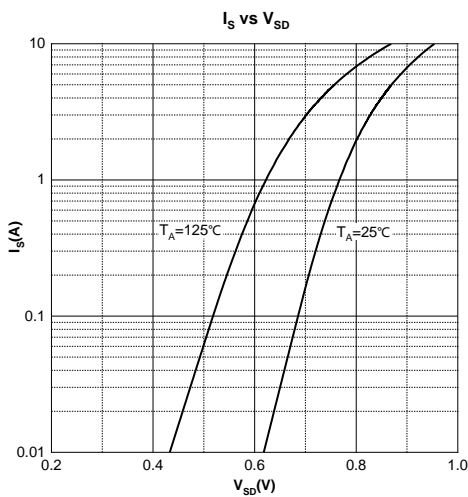
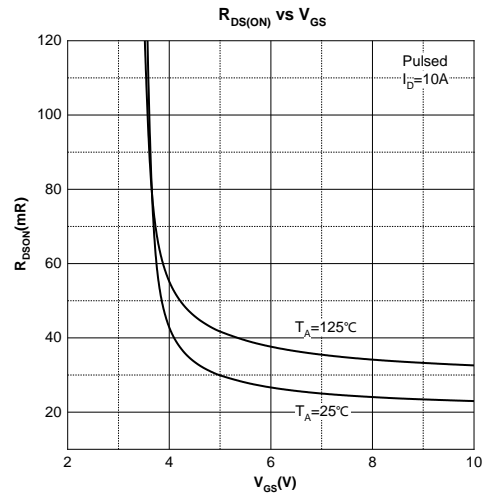
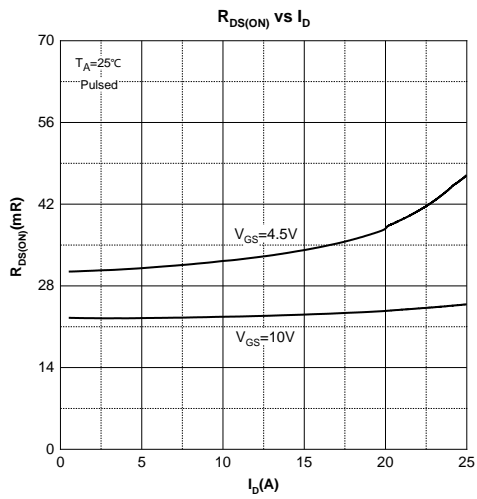
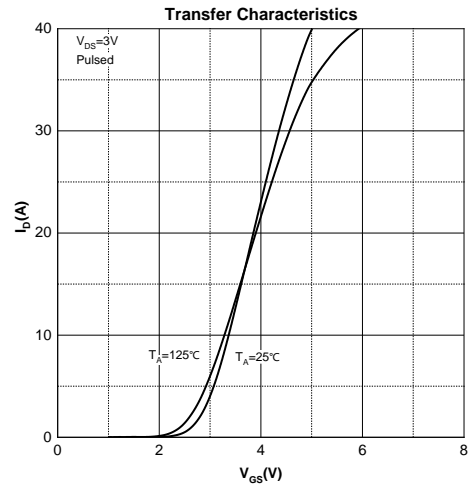
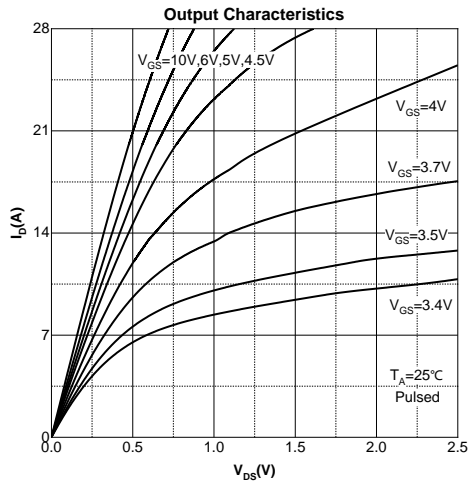

Typical Characteristics

PMOS:

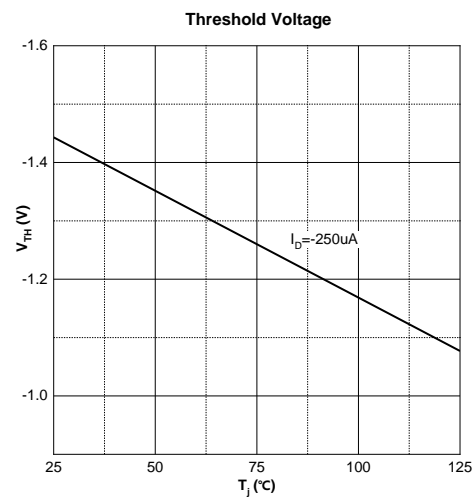
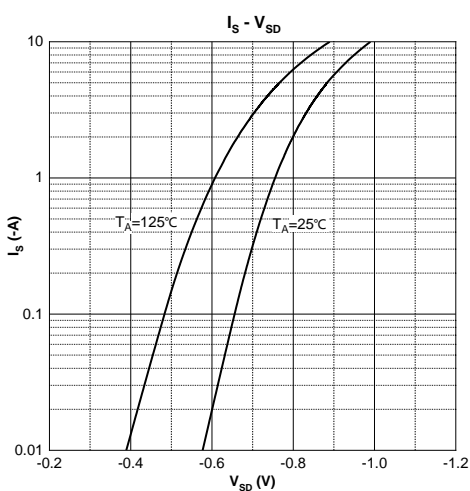
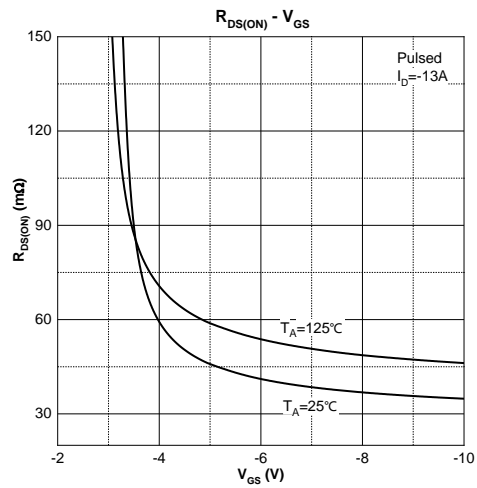
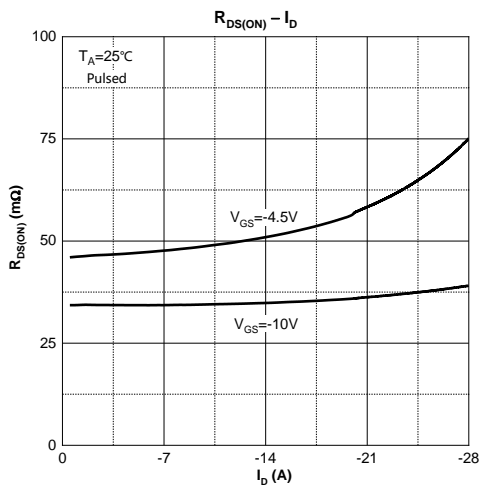
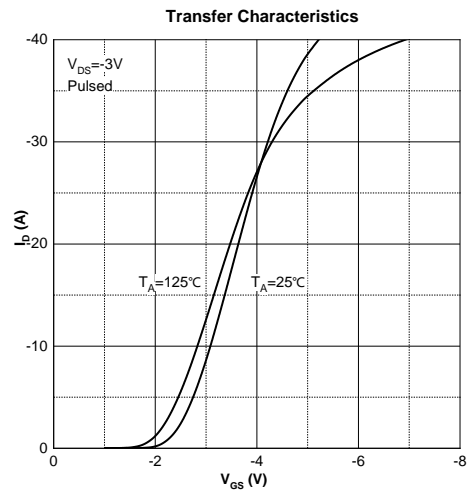
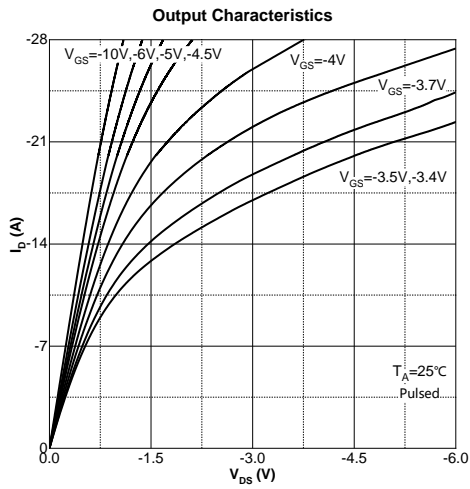

PDFN3.3X3.3-8L Package Information

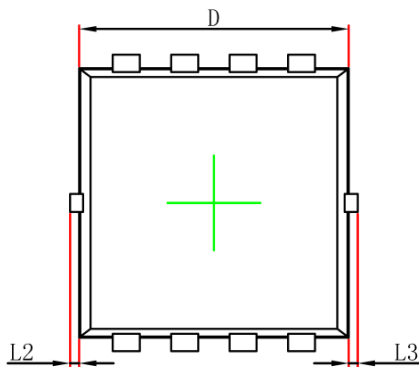

Top View
[顶视图]

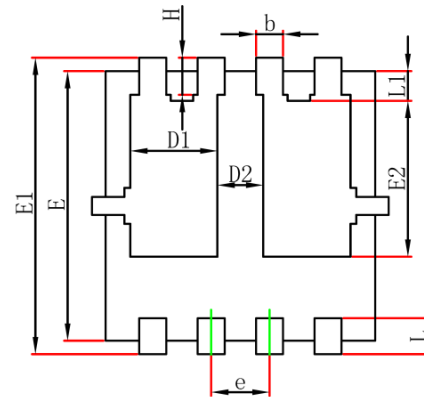

Bottom View
[背视图]

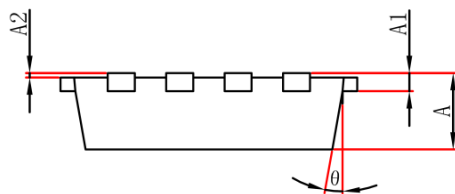

Side View
[侧视图]

Symbol	Dimensions In Millimeters		Dimensions In Inches	
	Min.	Max.	Min.	Max.
A	0.700	0.900	0.028	0.035
A1	0.152REF		0.006REF	
A2	0.000	0.050	0.000	0.002
D	2.900	3.200	0.114	0.126
D1	0.935	1.135	0.037	0.045
D2	0.280	0.480	0.011	0.019
E	2.900	3.200	0.114	0.126
E1	3.150	3.450	0.124	0.136
E2	1.535	1.935	0.060	0.076
b	0.200	0.400	0.008	0.016
e	0.550	0.750	0.022	0.030
L	0.300	0.500	0.012	0.020
L1	0.180	0.480	0.007	0.019
L2	0.000	0.100	0.000	0.004
L3	0.000	0.100	0.000	0.004
H	0.315	0.515	0.012	0.020
θ	0°	12°	0°	12°