



Product Summary

V _{(BR)DSS}	R _{DS(on)TYP}	I _D
20V	12.2mΩ@10V	7A
	13.5mΩ@4.5V	
	14.6mΩ@3.8V	
	17.8mΩ@2.5V	

Feature

- Trench Technology Power MOSFET
- Low R_{DS(ON)}
- Low Gate Charge
- ESD Protected

Application

- Load Switch
- DC/DC Converter

SOT-23-6L

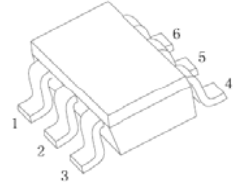

Schematic diagram

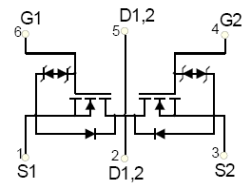

MARKING:

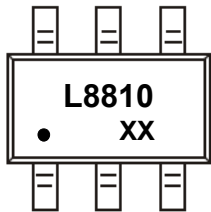

L8810 = Device Code
XX = Date Code
Solid Dot = Pin1 Indicator

ABSOLUTE MAXIMUM RATINGS (T_A = 25°C unless otherwise noted)

Parameter	Symbol	Value	Unit
Drain - Source Voltage	V _{DS}	20	V
Gate - Source Voltage	V _{GS}	±12	V
Continuous Drain Current ^{1,5}	I _D	7	A
Pulsed Drain Current ²	I _{DM}	28	A
Power Dissipation ^{4,5}	P _D	0.8	W
Thermal Resistance from Junction to Ambient ⁵	R _{θJA}	156	°C/W
Junction Temperature	T _J	150	°C
Storage Temperature	T _{STG}	-55~ +150	°C

MOSFET ELECTRICAL CHARACTERISTICS ($T_A = 25^\circ\text{C}$ unless otherwise noted)

Parameter	Symbol	Test Condition	Min	Type	Max	Unit
Off Characteristics						
Drain - Source Breakdown Voltage	$V_{(BR)DSS}$	$V_{GS} = 0V, I_D = 250\mu A$	20			V
Zero Gate Voltage Drain Current	I_{DSS}	$V_{DS} = 16V, V_{GS} = 0V$			1	μA
Gate - Body Leakage Current	I_{GSS}	$V_{GS} = \pm 10V, V_{DS} = 0V$			± 5	μA
On Characteristics³						
Gate Threshold Voltage	$V_{GS(th)}$	$V_{DS} = V_{GS}, I_D = 250\mu A$	0.4	0.75	1	V
Drain-source On-resistance	$R_{DS(on)}$	$V_{GS} = 10V, I_D = 3.0A$	10.5	12.2	18	m Ω
		$V_{GS} = 4.5V, I_D = 3.0A$	11.5	13.5	20	
		$V_{GS} = 3.8V, I_D = 3.0A$	12.6	14.6	22	
		$V_{GS} = 2.5V, I_D = 3.0A$	14.5	17.8	26	
Forward transconductance	g_{FS}	$V_{DS} = 5V, I_D = 7A$	9			S
Dynamic Characteristics						
Input Capacitance	C_{iss}	$V_{DS} = 10V, V_{GS} = 0V, f = 1MHz$		567		pF
Output Capacitance	C_{oss}			117		
Reverse Transfer Capacitance	C_{rss}			109		
Switching Characteristics						
Total Gate Charge	Q_g	$V_{DS} = 10V, V_{GS} = 4.5V, I_D = 5A$		17		nC
Gate-source Charge	Q_{gs}			0.6		
Gate-drain Charge	Q_{gd}			4.3		
Turn-on Delay Time	$t_{d(on)}$	$V_{DD} = 10V, V_{GS} = 4.5V,$ $R_L = 2\Omega, R_G = 3\Omega$		5		ns
Turn-on Rise Time	t_r			10		
Turn-off Delay Time	$t_{d(off)}$			35		
Turn-off Fall Time	t_f			12		
Source - Drain Diode Characteristics						
Diode Forward Voltage ³	V_{SD}	$V_{GS} = 0V, I_S = 1.0A$			1.2	V

Notes :

- 1.The maximum current rating is limited by package.
- 2.Pulse Test : Pulse Width $\leq 10\mu s$, duty cycle $\leq 1\%$.
- 3.Pulse Test : Pulse Width $\leq 300\mu s$, duty cycle $\leq 2\%$.
- 4.The power dissipation P_D is limited by $T_{J(MAX)} = 150^\circ\text{C}$.
- 5.Device mounted on $1in^2$ FR-4 board with 2oz. Copper, in a still air environment with $T_A = 25^\circ\text{C}$.

Typical Characteristics

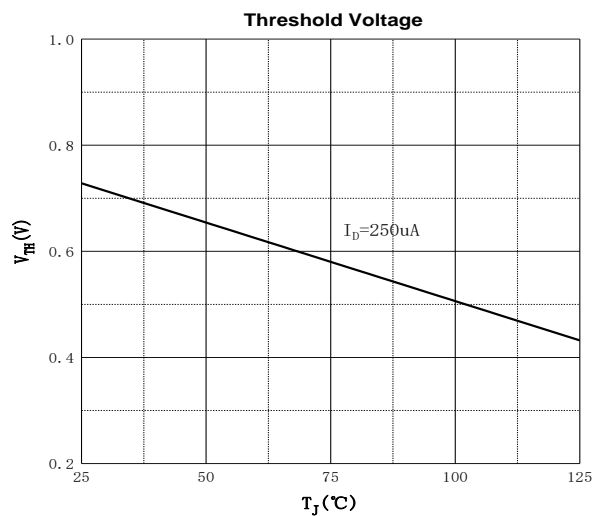
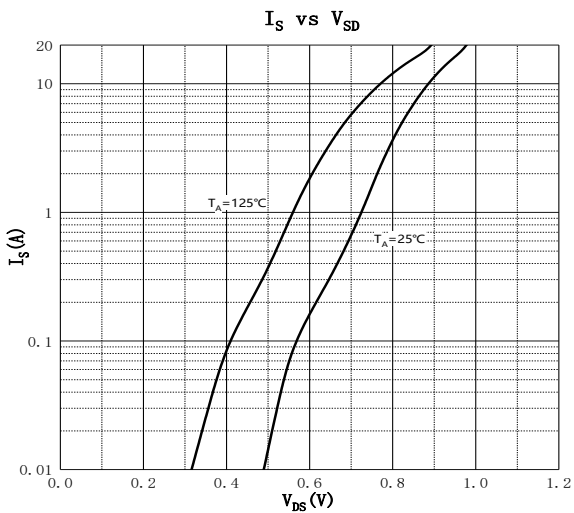
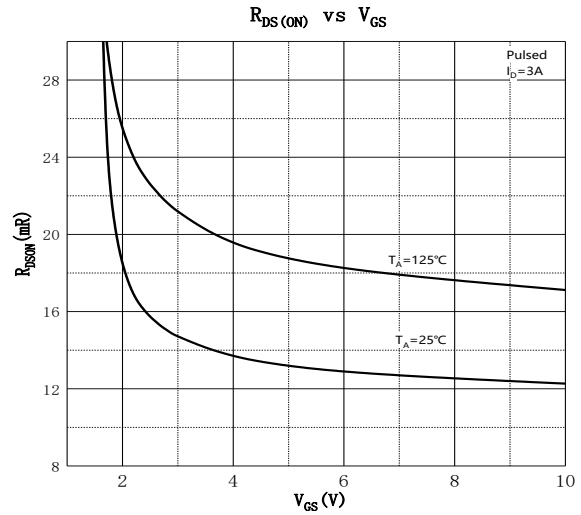
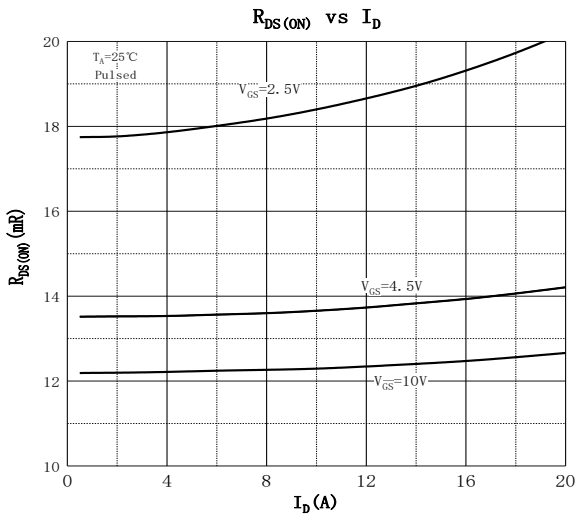
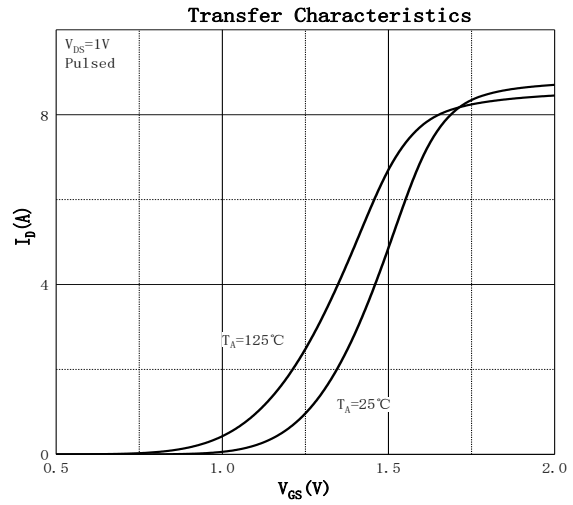
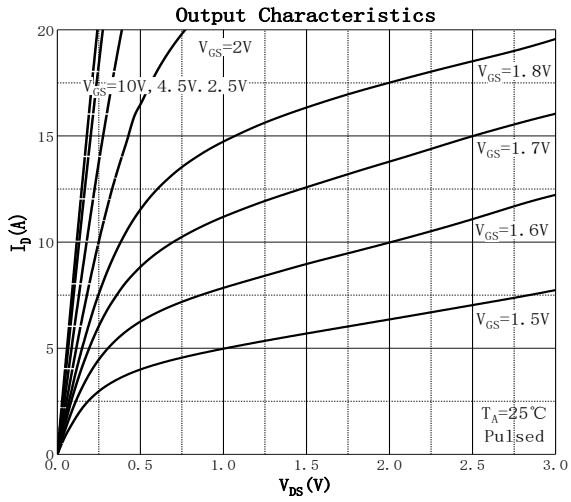

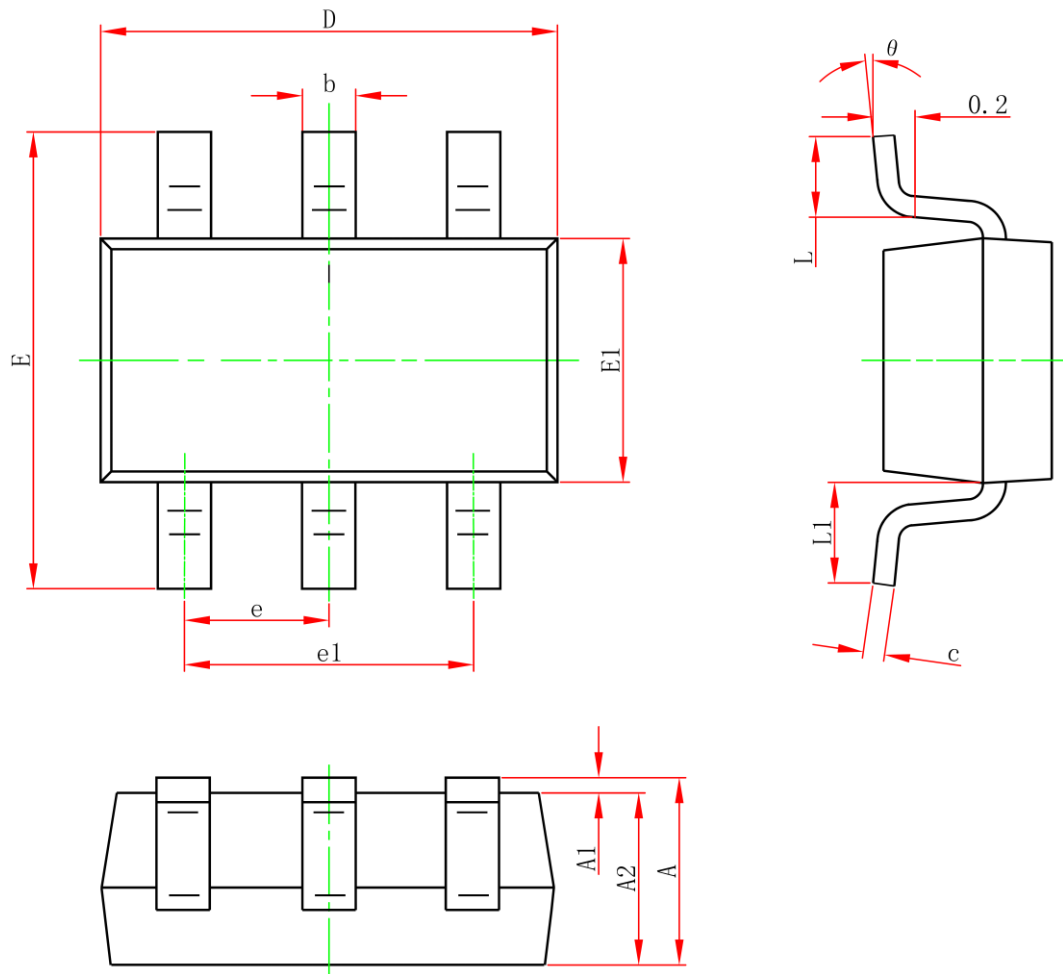
SOT-23-6L Package Information

Symbol	Dimensions In Millimeters		Dimensions In Inches	
	Min.	Max.	Min.	Max.
A	1.050	1.250	0.041	0.049
A1	0	0.150	0.000	0.006
A2	1.050	1.250	0.041	0.049
b	0.300	0.500	0.012	0.020
c	0.100	0.200	0.004	0.008
D	2.820	3.020	0.111	0.119
E	2.650	2.950	0.104	0.116
E1	1.500	1.700	0.059	0.067
e	0.950TYP		0.037TYP	
e1	1.800	2.000	0.071	0.079
L	0.300	0.600	0.012	0.024
L1	0.600REF		0.024REF	
θ	0°	8°	0°	8°