

### Product Summary

The GESDBP5V0C2 is designed to protect voltage sensitive electronic components from ESD and other transients. Excellent clamping capability, low leakage, low capacitance, and fast response time provide best in class protection on designs that are exposed to ESD.

The combination of small size, low capacitance, and high level of ESD protection makes them a flexible solution for applications such as HDMI, Display Port TM, and MDDI interfaces. It is designed to replace multiplayer varistors (MLV) in consumer equipment applications such as mobile phone, notebook, PAD, STB, LCD TV etc.

### Feature

- Low reverse stand-off voltage: 5.0V
- Low clamping voltage:  $V_{C_{MAX}} 16.7V @ IPP 25A$
- Low reverse clamping voltage
- Low leakage current
- Fast response time
- IEC 61000-4-2 Level 4 ESD protection

### Application

- CAN bus protection
- Automotive applications

### Marking: 5B2

SOT-23

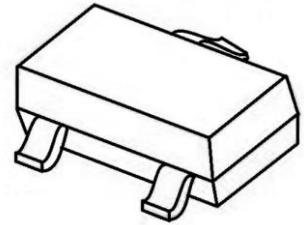

Schematic diagram

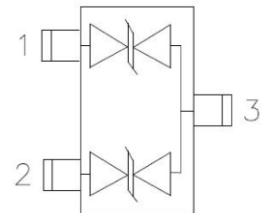

## Absolute Maximum Ratings ( $T_a=25^{\circ}\text{C}$ unless otherwise noted)

Parameter	Symbol	Value	Unit
IEC 61000-4-2 ESD Voltage	Air Model	$\pm 30$	kV
JESD22-A114-B ESD Voltage	Contact Model	$\pm 30$	
ESD Voltage	Per Human Body Model	$\pm 16$	
ESD Voltage	Machine Model	$\pm 0.4$	
Peak Pulse Power	$P_{PP}^{2)}$	417	W
Peak Pulse Current	$I_{PP}^{2)}$	25	A
Lead Solder Temperature – Maximum (10 Second Duration)	$T_L$	260	$^{\circ}\text{C}$
Junction Temperature	$T_j$	-55~ +150	$^{\circ}\text{C}$
Storage Temperature Range	$T_{stg}$	-55~ +150	$^{\circ}\text{C}$

- 1) Device stressed with ten non-repetitive ESD pulses.
- 2) Non-repetitive current pulse 8/20 $\mu\text{s}$  exponential decay waveform according to IEC61000-4-5.

## ESD Standards Compliance

### IEC61000-4-2 Standard

Contact Discharge		Air Discharge	
Level	Test Voltage kV	Level	Test Voltage kV
1	2	1	2
2	4	2	4
3	6	3	8
4	8	4	15

### JESD22-A114-B Standard

ESD Class	Human Body Discharge V
0	0~249
1A	250~499
1B	500~999
1C	1000~1999
2	2000~3999
3A	4000~7999
3B	8000~15999

### Contact discharge current waveform per IEC61000-4-2

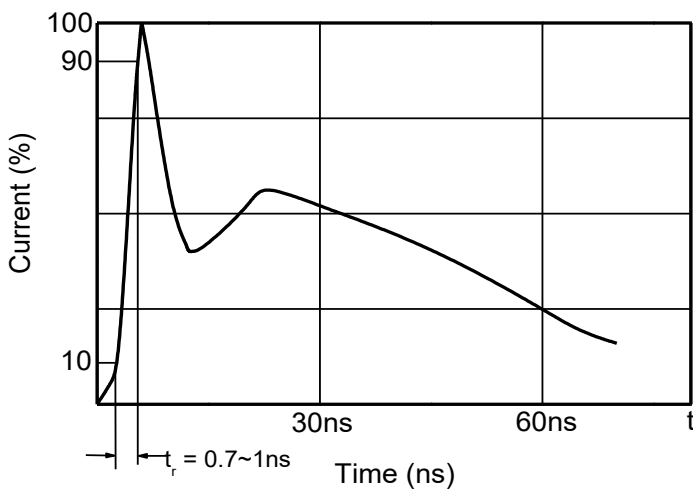

### 8/20 $\mu\text{s}$ waveform per IEC61000-4-5

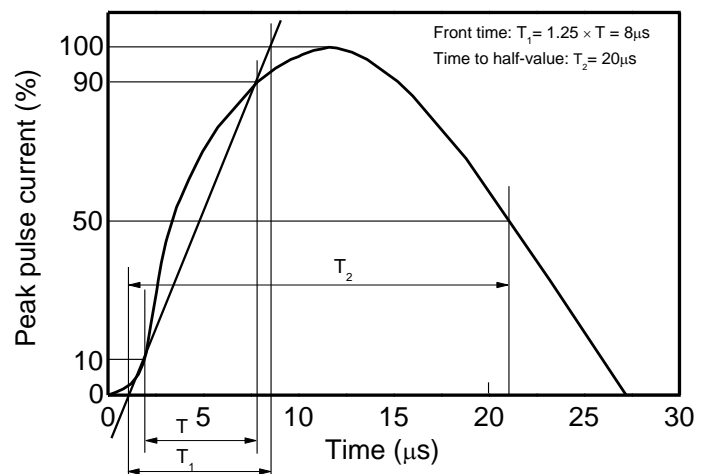

## Electrical Parameter

Symbol	Parameter
V <sub>C</sub>	Clamping Voltage @ I <sub>PP</sub>
I <sub>PP</sub>	Peak Pulse Current
V <sub>BR</sub>	Breakdown Voltage @ I <sub>T</sub>
I <sub>T</sub>	Test Current
I <sub>R</sub>	Reverse Leakage Current @ V <sub>RWM</sub>
V <sub>RWM</sub>	Reverse Standoff Voltage

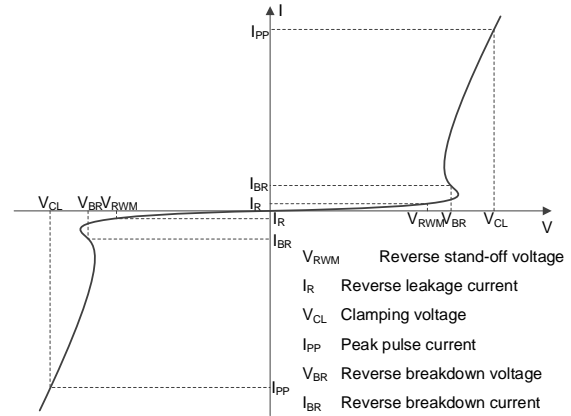

V-I characteristics for a Bi-directional TVS

## Electrical Characteristics (T<sub>a</sub>=25°C unless otherwise specified)

Parameter	Symbol	Test conditions	Min	Typ	Max	Unit
Reverse stand-off voltage	V <sub>RWM</sub> <sup>1)</sup>				5	V
Reverse leakage current	I <sub>R</sub>	V <sub>RWM</sub> =5.0V			1	μA
Breakdown voltage	V <sub>BR</sub>	I <sub>T</sub> =1mA	6		8	V
Clamping voltage	V <sub>C</sub> <sup>2)</sup>	I <sub>PP</sub> =1A			9.8	V
		I <sub>PP</sub> =25A			16.7	V
Junction capacitance	C <sub>J</sub>	V <sub>R</sub> =0V, f=1MHz			185	pF

- 1) Other voltages available upon request.
- 2) Non-repetitive current pulse 8/20μs exponential decay waveform according to IEC61000-4-5.

**Typical Characteristics**

**V<sub>C</sub> VS. I<sub>PP</sub>**

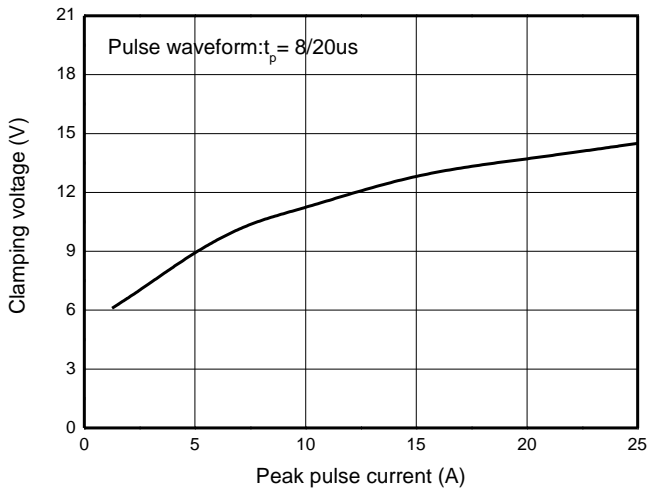

**I-V Curve**

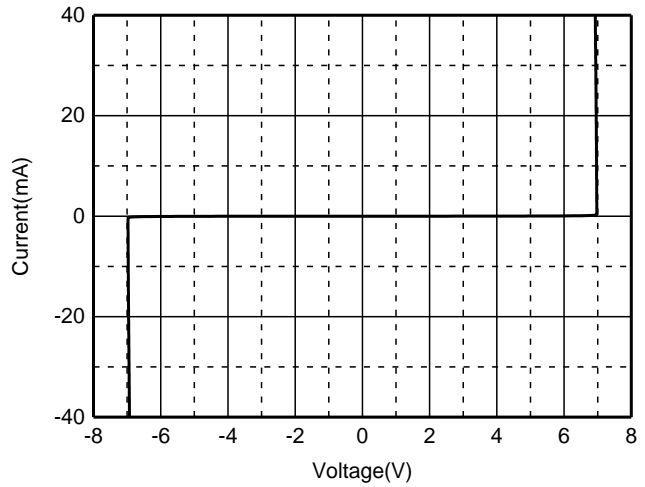

**Peak pulse power vs. Pulse time**

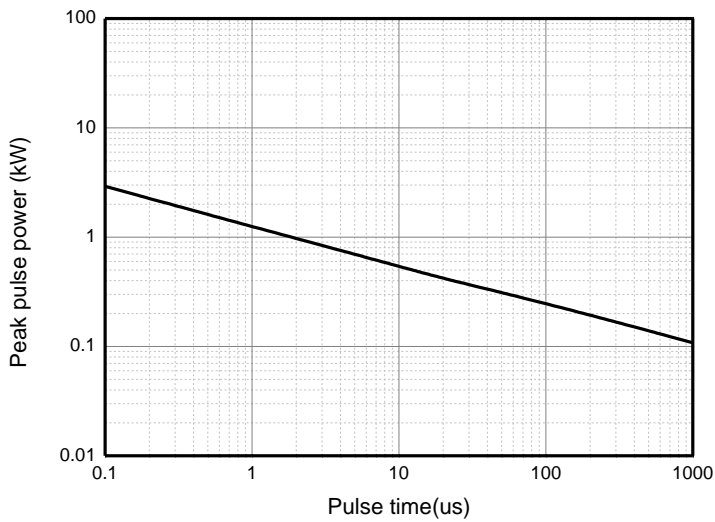

**Power derating vs. Ambient temperature**

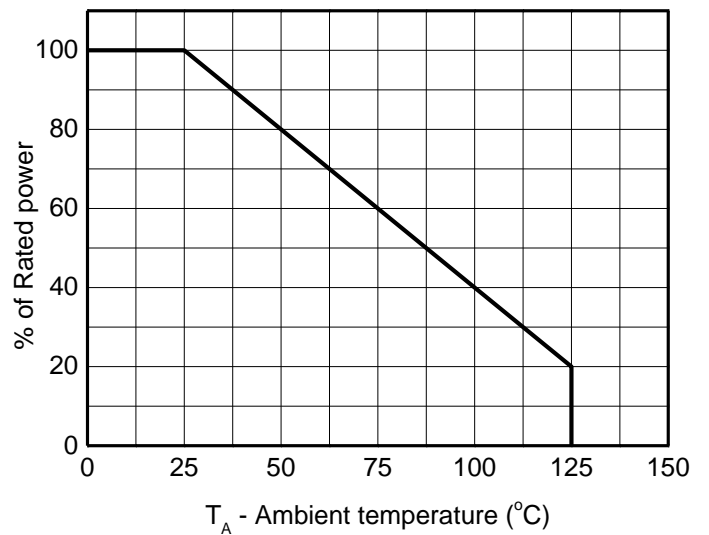

## SOT-23 Package Outline Dimensions

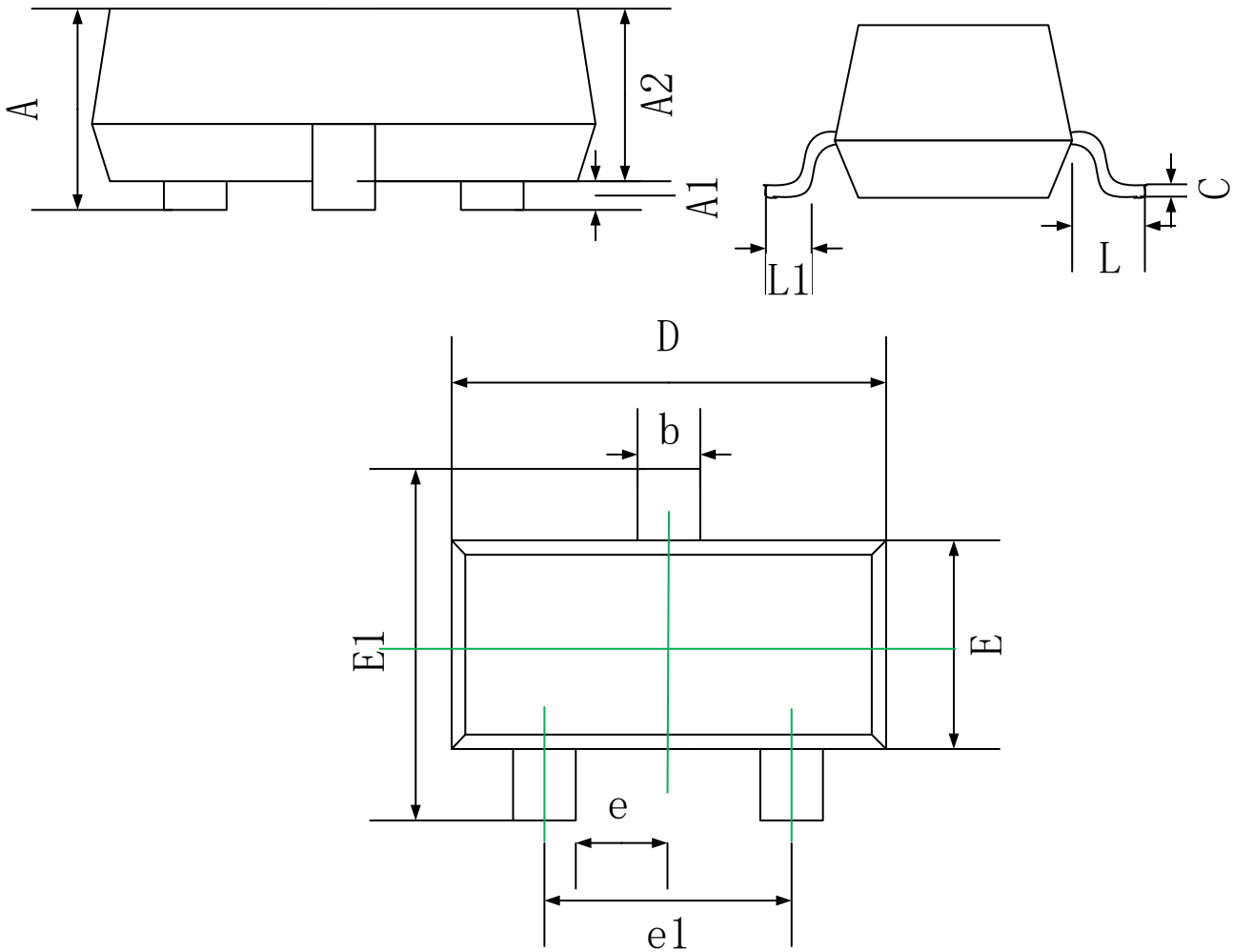

Symbol	Dimensions In Millimeters	
	Min.	Max.
A	0.90	1.15
A1	0.00	0.10
A2	0.90	1.05
b	0.30	0.50
c	0.08	0.15
D	2.80	3.00
E	1.20	1.40
E1	2.25	2.55
e	0.95 REF.	
e1	1.80	2.00
L	0.55 REF.	
L1	0.30	0.50