



Product Summary

$V_{(BR)DSS}$	$R_{DS(on)TYP}$	I_D
20V	21m Ω @4.5V	4.8A
	27m Ω @2.5V	

Feature

- TrenchFET Power MOSFET
- Excellent $R_{DS(on)}$ and Low Gate Charge

Application

- Advanced trench process technology
- High density cell design for ultra low on-resistance
- High power and current handling capability
- Ideal for Liion battery pack applications

MARKING:

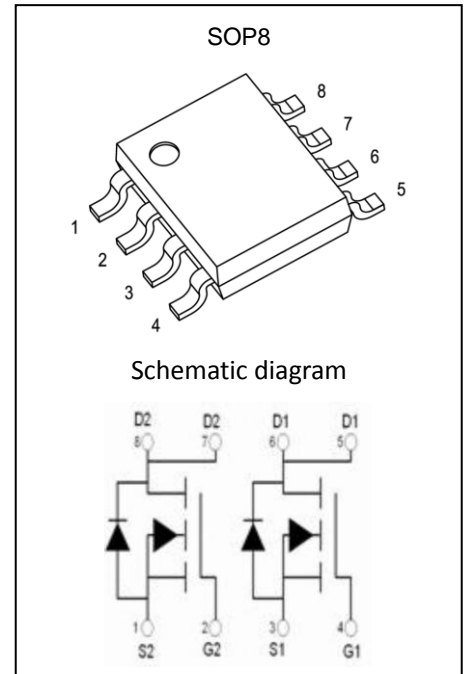
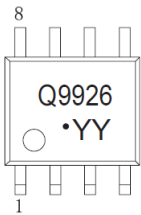

ABSOLUTE MAXIMUM RATINGS ($T_a=25^{\circ}\text{C}$ unless otherwise noted)

Parameter	Symbol	Value	Unit
Drain-Source Voltage	V_{DS}	20	V
Gate-Source Voltage	V_{GS}	± 12	V
Continuous Drain Current	I_D	4.8	A
Pulsed Drain Current ⁽¹⁾	I_{DM}	30	A
Power Dissipation	P_D	1.25	W
Thermal Resistance from Junction to Ambient ⁽²⁾	$R_{\theta JA}$	100	$^{\circ}\text{C/W}$
Junction Temperature	T_J	150	$^{\circ}\text{C}$
Storage Temperature	T_{STG}	-55~ +150	$^{\circ}\text{C}$

MOSFET ELECTRICAL CHARACTERISTICS(T_a=25°C unless otherwise noted)

Parameter	Symbol	Test Condition	Min	Type	Max	Unit
STATIC CHARACTERISTICS						
Drain-source breakdown voltage	V _{(BR)DSS}	V _{GS} = 0V, I _D =250μA	20			V
Zero gate voltage drain current	I _{DSS}	V _{DS} =20V, V _{GS} = 0V			1	μA
Gate-body leakage current	I _{GSS}	V _{GS} =±12V, V _{DS} = 0V			±100	nA
Gate threshold voltage ⁽³⁾	V _{GS(th)}	V _{DS} =V _{GS} , I _D =250μA	0.6	0.8	1.2	V
Drain-source on-resistance ⁽³⁾	R _{DS(on)}	V _{GS} =4.5V, I _D =6A		21	30	mΩ
		V _{GS} =2.5V, I _D =5A		27	40	
Forward tranconductance ⁽³⁾	g _{FS}	V _{DS} =15V, I _D =6A	15			S
DYNAMIC CHARACTERISTICS⁽⁴⁾						
Input Capacitance	C _{iss}	V _{DS} =8V, V _{GS} =0V, f=1MHz		523		pF
Output Capacitance	C _{oss}			99		
Reverse Transfer Capacitance	C _{rss}			75		
SWITCHING CHARACTERISTICS⁽⁴⁾						
Turn-on delay time	t _{d(on)}	V _{GS} =4.5V, V _{DS} =10V, I _D =1A, R _{GEN} =6Ω		10.5	21	ns
Turn-on rise time	t _r			4.5	9	
Turn-off delay time	t _{d(off)}			27.5	55	
Turn-off fall time	t _f			4.3	8.6	
Total gate charge	Q _g	V _{DS} =10V, V _{GS} =4.5V, I _D =6A		6.4	8.2	nC
Gate-source charge	Q _{gs}			1.8	2.3	
Gate-drain charge	Q _{gd}			1.3	1.9	
SOURCE-DRAIN DIODE CHARACTERISTICS						
Body Diode Voltage ⁽³⁾	V _{SD}	I _S =1.7A, V _{GS} = 0V		0.8	1.2	V
Continuous Source-Drain Diode Current	I _S	T _C =25°C			1.7	A

Notes:

1. Repetitive rating : Pulse width limited by junction temperature.
2. Surface mounted on FR4 board , t_s≤10s.
3. Pulse Test : Pulse Width≤80μs, Duty Cycle≤0.5%.
4. Guaranteed by design, not subject to producing.

Typical Electrical and Thermal Characteristics

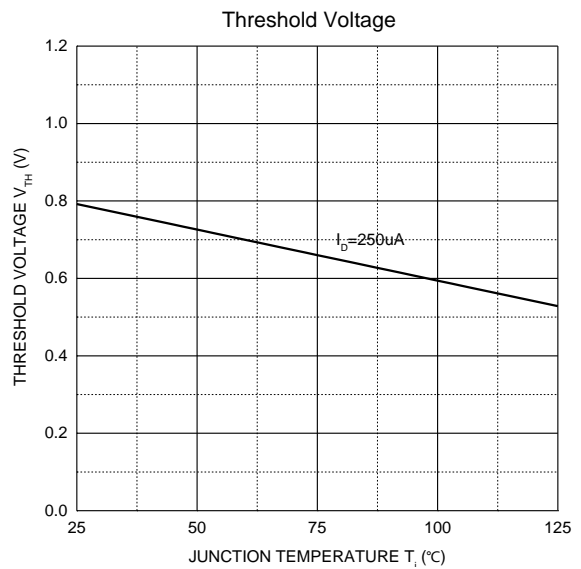
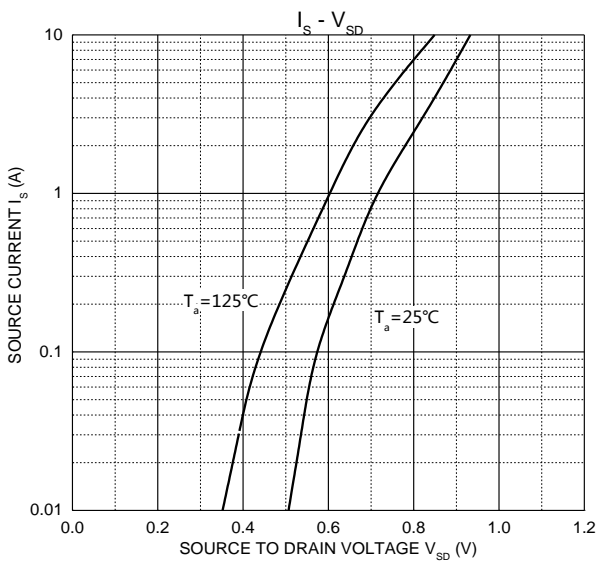
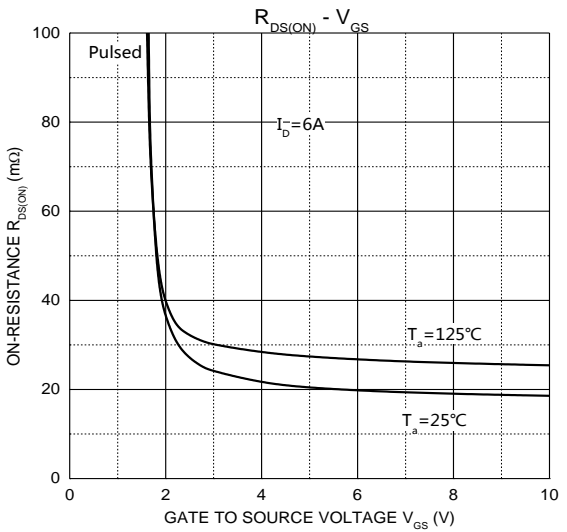
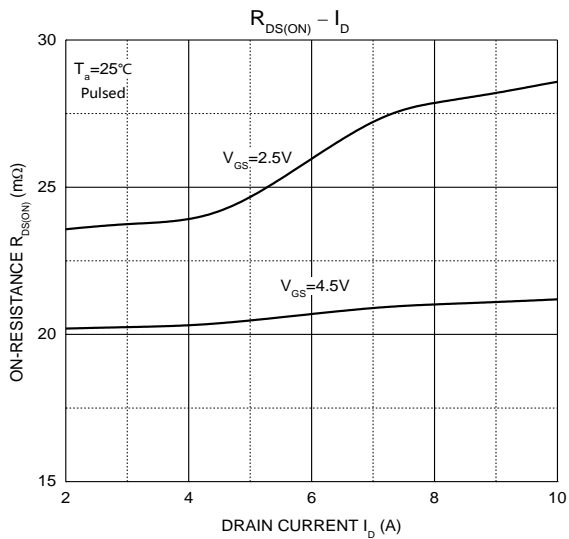
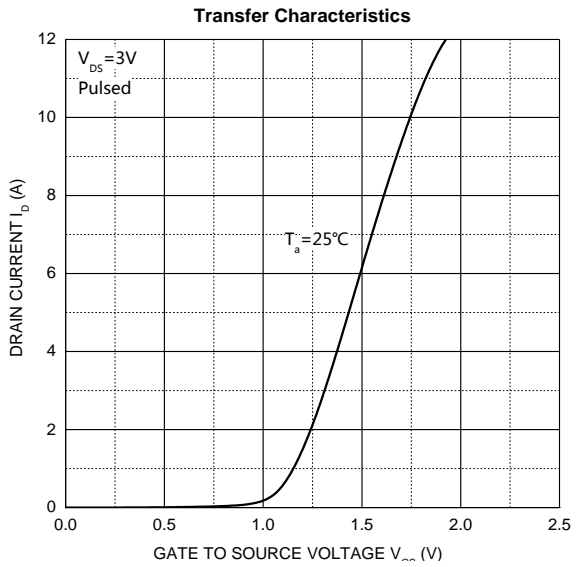
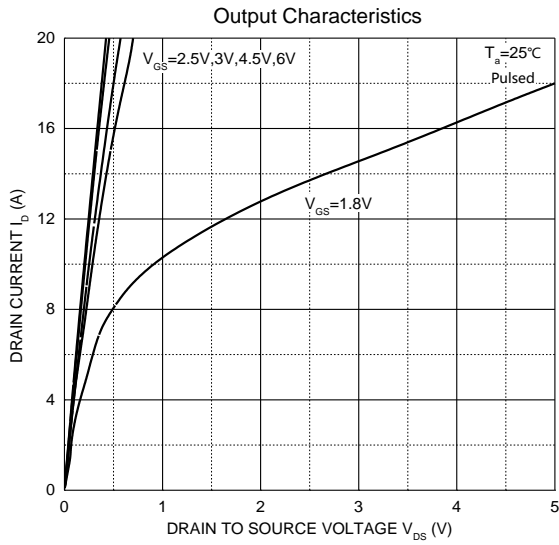

SOP8 Package Information

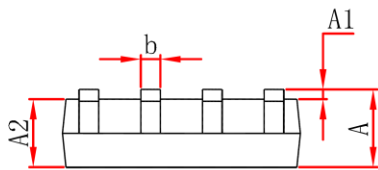
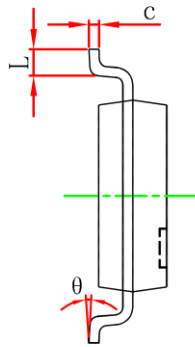
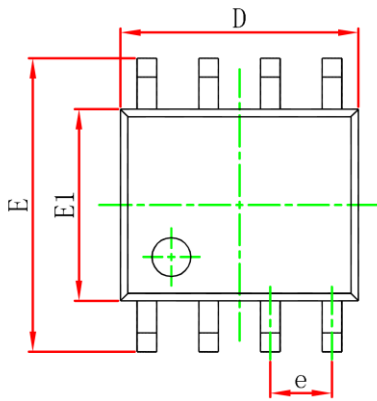

Symbol	Dimensions In Millimeters		Dimensions In Inches	
	Min	Max	Min	Max
A	1.350	1.750	0.053	0.069
A1	0.100	0.250	0.004	0.010
A2	1.350	1.550	0.053	0.061
b	0.330	0.510	0.013	0.020
c	0.170	0.250	0.007	0.010
D	4.800	5.000	0.189	0.197
e	1.270 (BSC)		0.050 (BSC)	
E	5.800	6.200	0.228	0.244
E1	3.800	4.000	0.150	0.157
L	0.400	1.270	0.016	0.050
θ	0°	8°	0°	8°

SOP8 Tape and Reel

SOP8 Embossed Carrier Tape

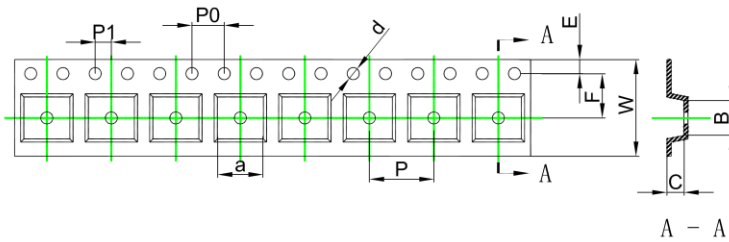

Dimensions are in millimeter										
Pkg type	a	B	C	d	E	F	P0	P	P1	W
SOP8	6.40	5.40	2.10	Ø1.50	1.75	5.50	4.00	8.00	2.00	12.00

SOP8 Tape Leader and Trailer

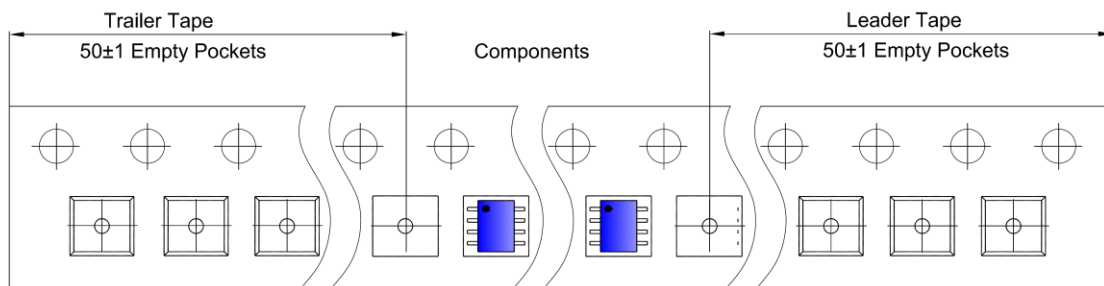

SOP8 Reel

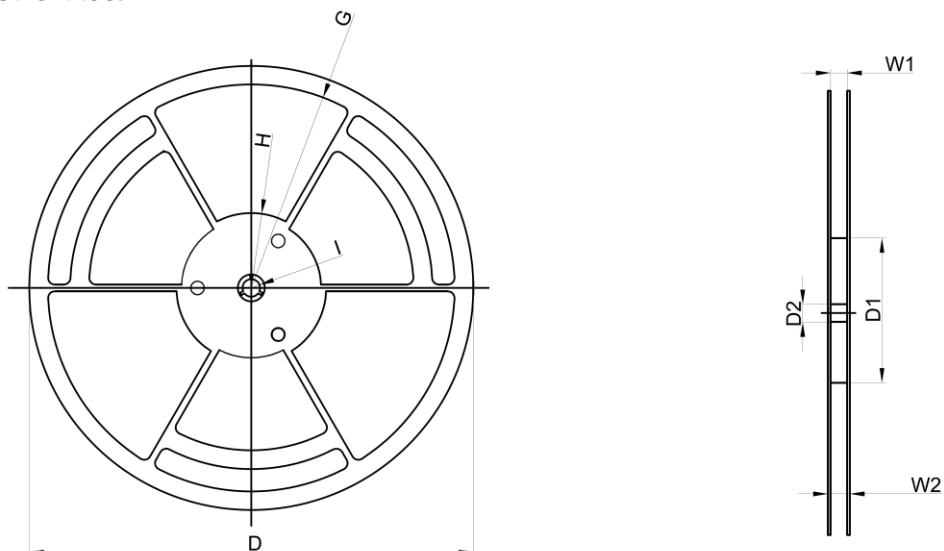

Dimensions are in millimeter								
Reel Option	D	D1	D2	G	H	I	W1	W2
13" Dia	Ø330.00	100.00	13.00	R151.00	R56.00	R6.50	12.40	17.60

REEL	Reel Size	Box	Box Size(mm)	Carton	Carton Size(mm)	G.W.(kg)
4,000 pcs	13 inch	8,000 pcs	360×360×65	64,000 pcs	565×380×390	