



Product Summary

$V_{(BR)DSS}$	$R_{DS(on)TYP}$	I_D
100V	19m Ω @10V	35A
	25m Ω @4.5V	

Feature

- Split Gate Trench Technology
- Low $R_{DS(ON)}$
- Low Gate Charge
- Low Gate Resistance
- 100% UIS Tested

Application

- Industrial Power Supply
- Load Switch

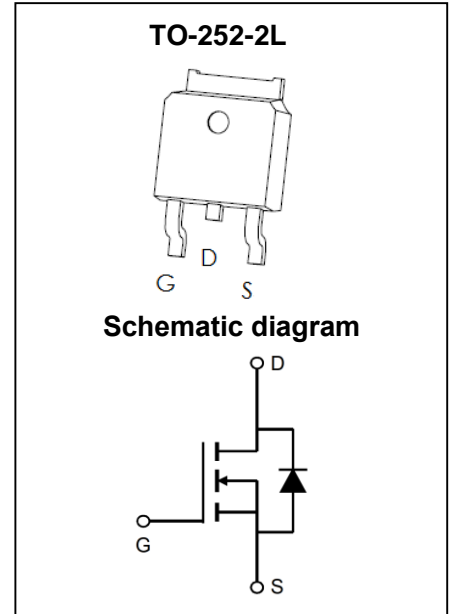

MARKING:

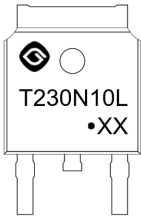

T230N10L = Device Code
 XX = Date Code
 Solid Dot = Green Indicator

ABSOLUTE MAXIMUM RATINGS ($T_A = 25^\circ\text{C}$ unless otherwise noted)

Parameter	Symbol	Value	Unit
Drain - Source Voltage	V_{DS}	100	V
Gate - Source Voltage	V_{GS}	± 20	V
Continuous Drain Current ¹	I_D	35	A
	$T_C = 25^\circ\text{C}$		
Pulsed Drain Current ²	I_{DM}	140	A
Single Pulsed Avalanche Current ³	I_{AS}	12	A
Single Pulsed Avalanche Energy ³	E_{AS}	7.2	mJ
Power Dissipation ⁵	P_D	44.6	W
	$T_C = 25^\circ\text{C}$		
Thermal Resistance from Junction to Ambient ⁶	$R_{\theta JA}$	50	$^\circ\text{C/W}$
Thermal Resistance from Junction to Case	$R_{\theta JC}$	2.8	$^\circ\text{C/W}$
Junction Temperature	T_J	150	$^\circ\text{C}$
Storage Temperature	T_{STG}	-55~ +150	$^\circ\text{C}$

MOSFET ELECTRICAL CHARACTERISTICS ($T_J = 25^\circ\text{C}$ unless otherwise noted)

Parameter	Symbol	Test Condition	Min	Type	Max	Unit
Off Characteristics						
Drain - Source Breakdown Voltage	$V_{(BR)DSS}$	$V_{GS} = 0V, I_D = 250\mu A$	100			V
Zero Gate Voltage Drain Current	I_{DSS}	$V_{DS} = 100V, V_{GS} = 0V$			1	μA
Gate - Body Leakage Current	I_{GSS}	$V_{GS} = \pm 20V, V_{DS} = 0V$			± 100	nA
On Characteristics⁴						
Gate Threshold Voltage	$V_{GS(th)}$	$V_{DS} = V_{GS}, I_D = 250\mu A$	1	1.5	3	V
Drain-source On-resistance	$R_{DS(on)}$	$V_{GS} = 10V, I_D = 20A$		19	25	m Ω
		$V_{GS} = 4.5V, I_D = 15A$		25	33	
Forward Transconductance	g_{FS}	$V_{DS} = 5V, I_D = 20A$		53		S
Dynamic Characteristics						
Input Capacitance	C_{iss}	$V_{DS} = 45V, V_{GS} = 0V, f = 1MHz$		781		pF
Output Capacitance	C_{oss}			277.3		
Reverse Transfer Capacitance	C_{rss}			14.1		
Gate Resistance	R_g	$V_{DS} = 0V, V_{GS} = 0V, f = 1MHz$		2.0		Ω
Switching Characteristics						
Total Gate Charge	Q_g	$V_{DS} = 50V, V_{GS} = 10V, I_D = 20A$		14.6		nC
Gate-source Charge	Q_{gs}			1.3		
Gate-drain Charge	Q_{gd}			4.3		
Turn-on Delay Time	$t_{d(on)}$	$V_{DD} = 50V, V_{GS} = 10V, R_L = 2.5\Omega$ $R_G = 3\Omega$		7.5		ns
Turn-on Rise Time	t_r			3.5		
Turn-off Delay Time	$t_{d(off)}$			23		
Turn-off Fall Time	t_f			4.5		
Source - Drain Diode Characteristics						
Diode Forward Voltage ⁴	V_{SD}	$V_{GS} = 0V, I_S = 10A$	0.5		1.2	V

Notes :

- 1.The maximum current rating is limited by package.And device mounted on a large heatsink
- 2.Pulse Test : Pulse Width $\leq 10\mu s$, duty cycle $\leq 1\%$.
- 3.EAS condition: $V_{DD} = 50V, V_{GS} = 10V, L = 0.1mH, R_G = 25\Omega$ Starting $T_J = 25^\circ\text{C}$.
- 4.Pulse Test : Pulse Width $\leq 300\mu s$, duty cycle $\leq 2\%$.
- 5.The power dissipation P_D is limited by $T_{J(MAX)} = 150^\circ\text{C}$.And device mounted on a large heatsink
- 6.Device mounted on $1in^2$ FR-4 board with 2oz. Copper, in a still air environment with $T_A = 25^\circ\text{C}$.

Typical Characteristics

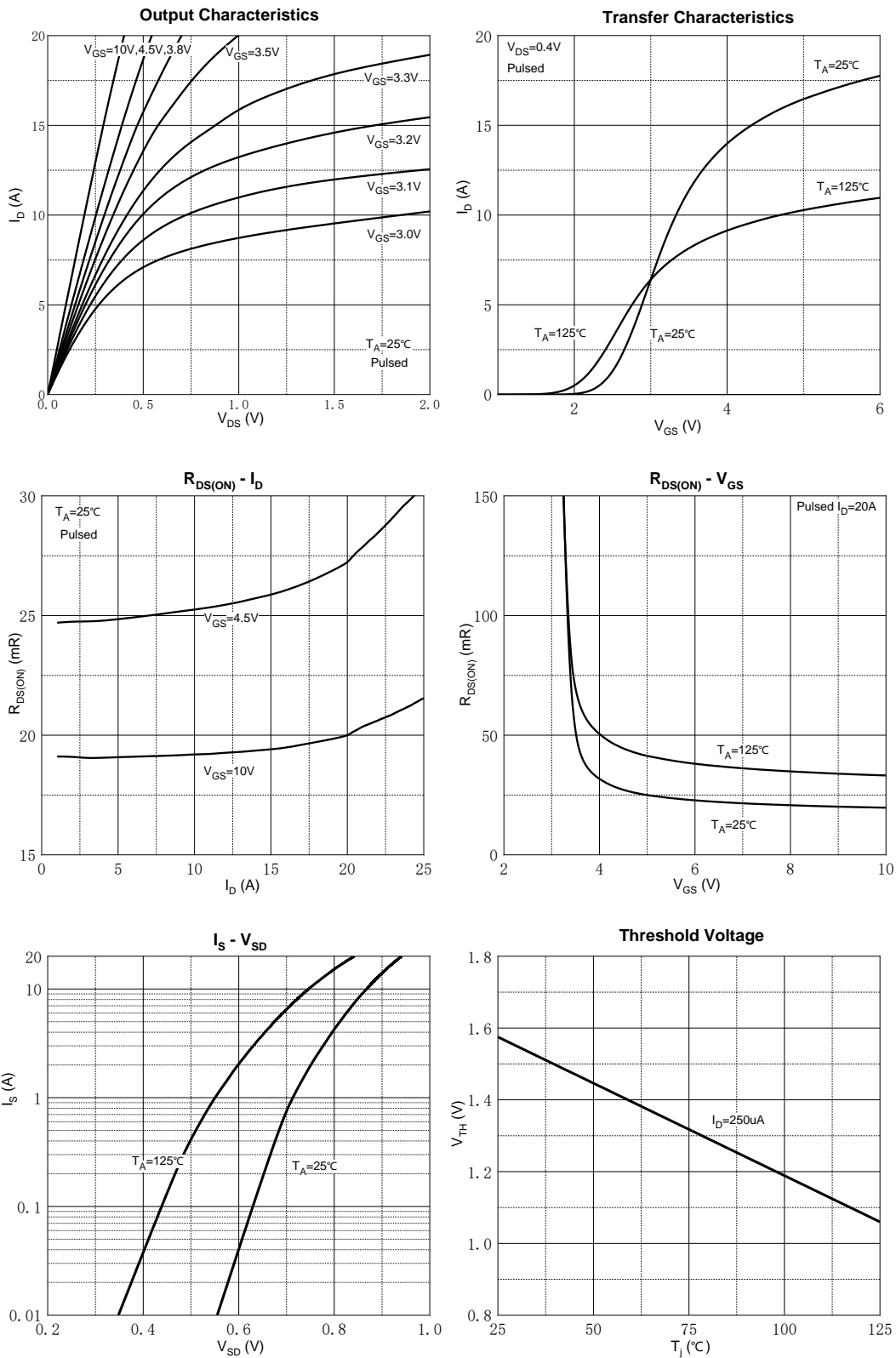

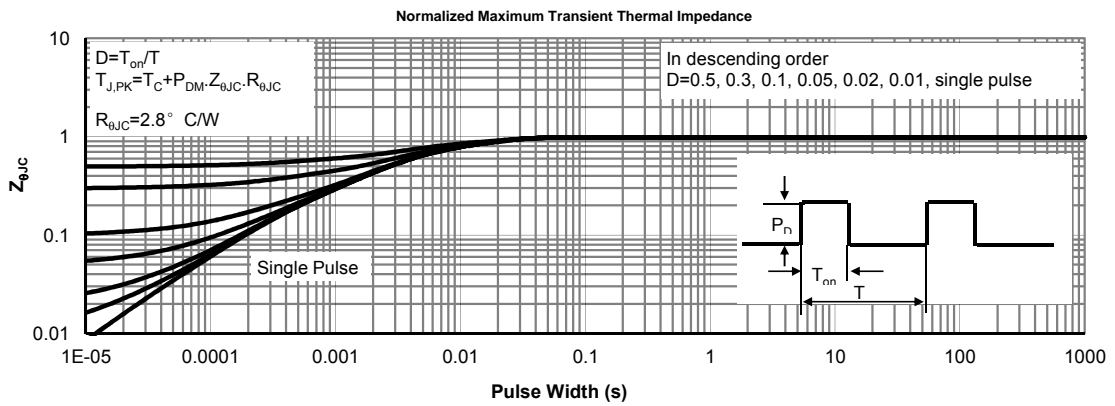
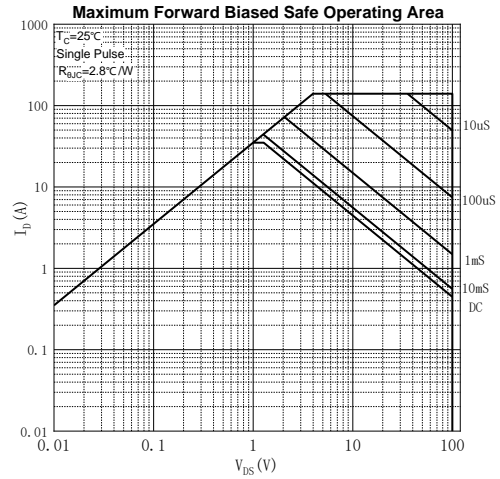
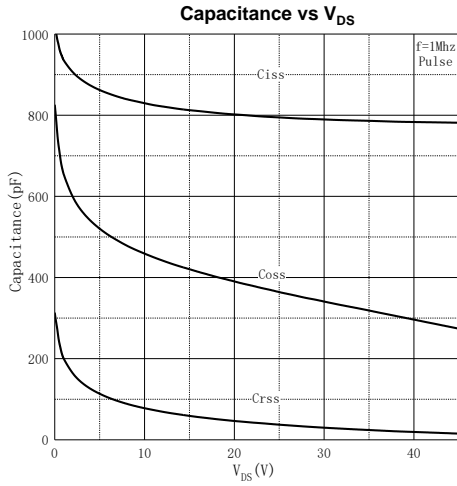

TO-252-2L Package Information

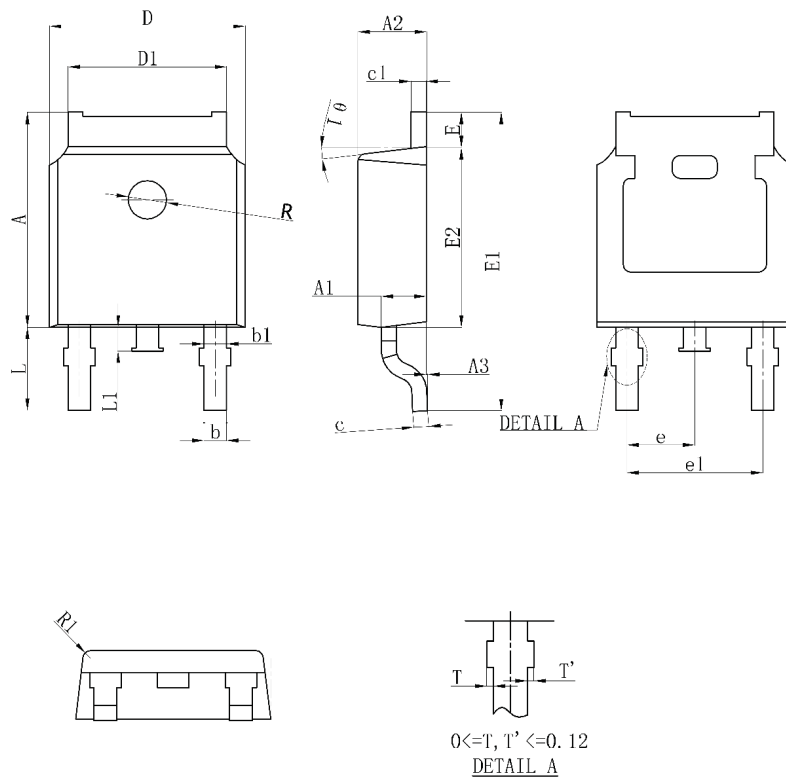

Symbol	Dimensions In Millimeters		Dimensions In Inches	
	Min.	Max.	Min.	Max.
A	7.050	7.150	0.278	0.281
A1	0.960	1.060	0.038	0.042
A2	2.200	2.400	0.087	0.094
A3	0.000	0.100	0.000	0.004
b	0.760REF		0.030REF	
b1	1.000REF		0.039REF	
c	0.508REF		0.020REF	
c1	0.508REF		0.020REF	
D	6.550	6.650	0.258	0.262
D1	5.100	5.460	0.201	0.215
E	0.950	1.050	0.037	0.041
E1	9.700	10.400	0.382	0.409
E2	6.000	6.200	0.236	0.244
e	2.286BSC		0.090BSC	
e1	4.572REF		0.180REF	
L	2.650	2.950	0.104	0.116
L1	0.700	0.900	0.028	0.035
θ	7°REF		7°REF	
R	1.300REF		0.051REF	
R1	0.250REF		0.010REF	